

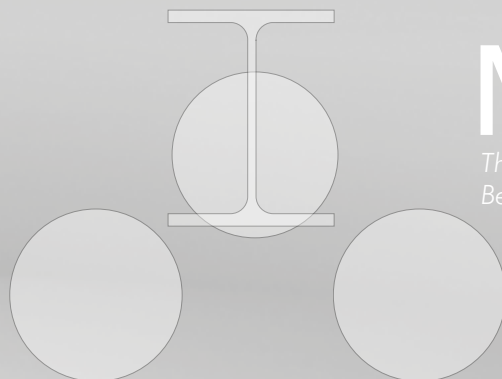

EXCELLENCE IN FORMING

[www.davi.com](http://www.davi.com)



**MCP**

*Three Rolls Section  
Bending Machine (Double Pinch)*



**SOLID, COMPACT AND MOST ADVANCED TECHNOLOGY**  
For the best productivity



**A COMPLETE RANGE OF QUALITY  
AND HEAVY DUTY MACHINES**

.....

**THREE POWERED ROLLS**  
WITH THREE SYNCHRONIZED HYDRAULIC MOTORS  
(ONE FOR EACH ROLL) TO CARRY MORE  
TORQUE AND TO FEED EASIER ANY SECTION

.....

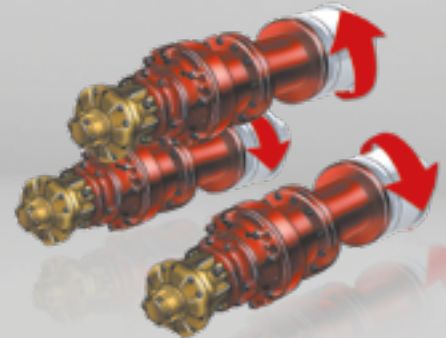

**ALL MACHINES EQUIPPED WITH  
3-D GUIDING ROLL**  
TO GUIDE AND CORRECT  
AT THE BEST ANY SECTION  
FROM DEFLECTING

.....

**STRONGER, PRECISE AND MORE RELIABLE...**  
**...New DAVI MCP Angle Roll!**



**THE ENTIRE RANGE OF DAVI ANGLE ROLLS OFFER UNCOMPARABLE BENEFITS**



- A:** Large diameter shafts
- B:** Modular rolls perfectly interchangeable with any standard, universal and special customized roll
- C:** Heavy duty hydraulic guide rolls
- D:** Sturdy, high resistance frame
- E:** Hydraulic pulling roll unit for bending I - U and H beams the hard way





**UNIVERSAL ROLLS**

THE MACHINE IS SUPPLIED WITH ONE SET OF "UNIVERSAL" ROLLS AS STANDARD EQUIPMENT, ABLE TO BEND THE MOST COMMON SECTIONS

.....

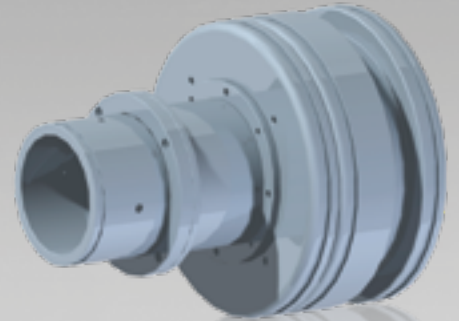

**AN ENDLESS RANGE OF ACCESSORIES**  
TO ANSWER TO ANY NEEDS

.....

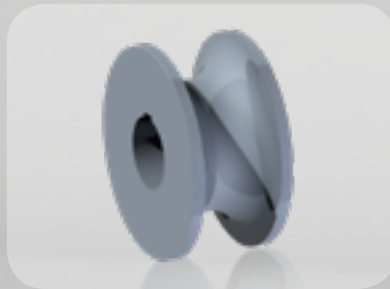

**HYDRAULIC PULLING ROLL UNIT**  
FOR BENDING I - U AND H BEAMS THE HARD WAY

.....



**ROLLS FOR HYDRAULIC PULLING**  
UNIT FOR HEA - HEB AND IPE SECTIONS

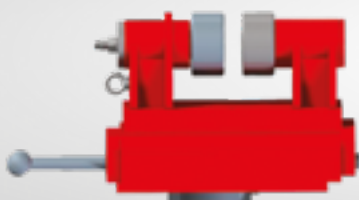

**ROLLS FOR HYDRAULIC PULLING**  
UNIT FOR IPN SECTIONS

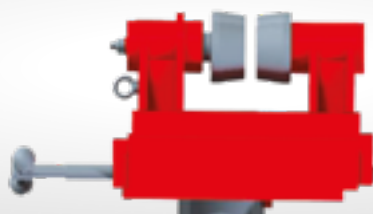

**ROLLS FOR HYDRAULIC PULLING**  
UNIT FOR UPN SECTIONS

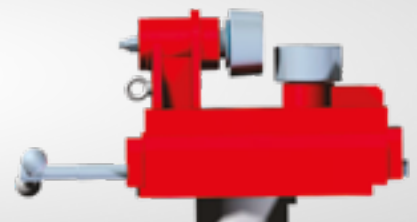



**STRONGER, PRECISE AND MORE RELIABLE...**  
**...New DAVI MCP Angle Roll!**



**PITCH CONTROL FOR SPIRAL BENDING**  
.....



**CONICAL SPIRAL**  
.....

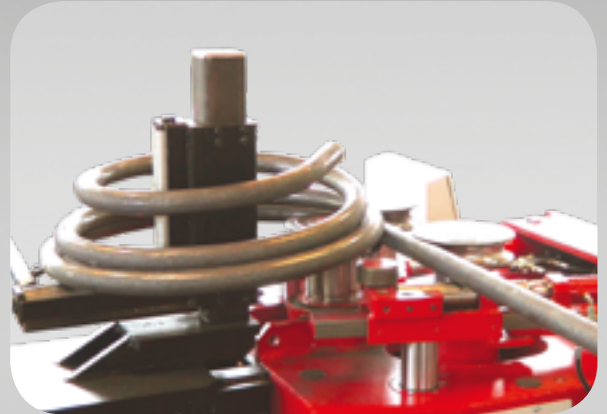

**HORIZONTAL CONVEYOR FOR BOILERS SPIRALS**  
.....



**SPECIAL ROLLS FOR BULB FLATS**  
.....

**SPECIAL ROLLS FOR TUBE BENDING**  
.....



**HOLLOW SECTIONS MANDRELS BENDING**  
.....



**3D SYSTEM**





SOLID, COMPACT AND MOST ADVANCED TECHNOLOGY  
For the best productivity



**SMALL**

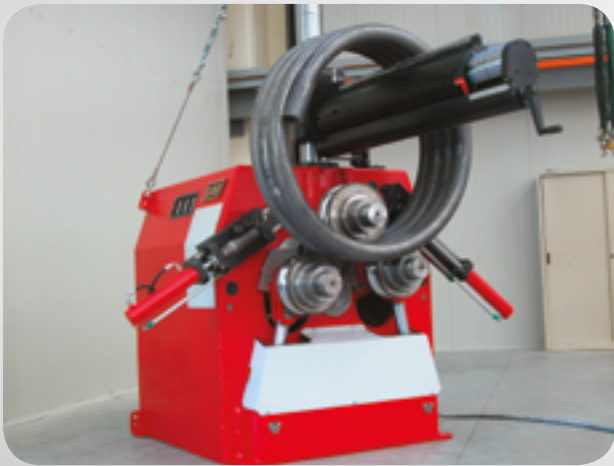

MCP 11 TUBE 141 mm



MCP 14 SQUARE BAR 80 x 80



MCP 11 ANGLE IRON 100 x 12 Ø1000



MCP 14 PIPE 141 x 6 Ø1150



## MEDIUM



MCP 20 HEB 180



MCP 20 HEA 200



MCP 26 TUBE 324 mm



MCP 26 IPE 270



# HEAVY



MCP 32 SQUARE HOLLOW 225 x 12

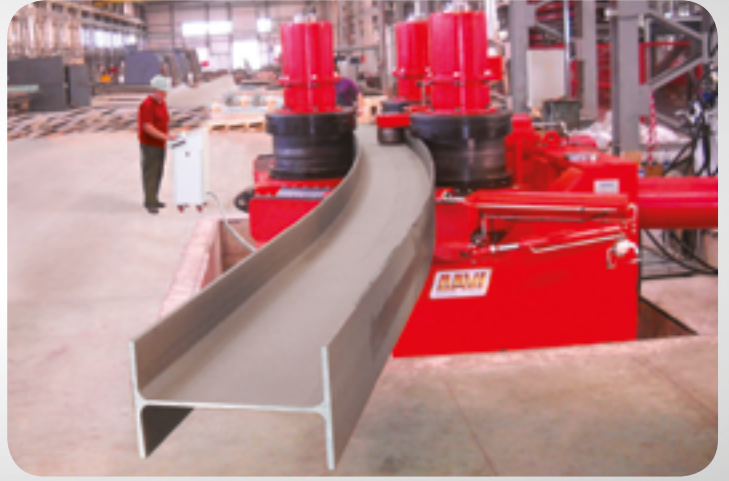

MCP 32 HEA 300



MCP 36 HEA 550



MCP 30 IPE 500

**STRONGER, PRECISE AND MORE RELIABLE...**  
**...New DAVI MCP Angle Roll!**



## CUSTOM



MCP BULB FLAT 340 x15



MCP PIPE 610 x 17,5 Ø15.000



MCP 36 HEA 550



MCP SQUARE BAR 340 Ø2400



**STRONGER, PRECISE AND MORE RELIABLE...**  
...New DAVI MCP Angle Roll!







**SOLID, COMPACT AND MOST ADVANCED TECHNOLOGY**  
For the best productivity

## KNOW-HOW

DAVI engineering has 50 years of technological experience in the heavy bending industry.

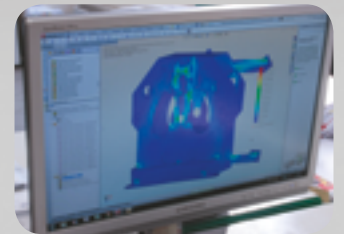
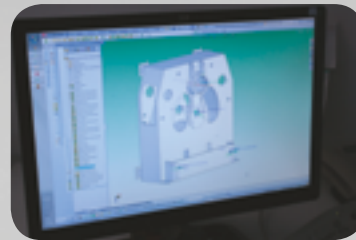

## DAVI UTMOST LEVEL OF QUALITY CONTROL

100% Made in Italy, total quality management (ISO 9001).



ISO  
9001



## READY FOR IMMEDIATE DELIVERY

Dozens of machines (often more than 100), even those for heavy industries, are finished and ready for immediate delivery. As the production is determined not only on orders received, but for its own inventory, DAVI can offer THE SHORTEST DELIVERY TIME.



**STRONGER, PRECISE AND MORE RELIABLE...**  
**...New DAVI MCP Angle Roll!**



### THE ONLY CUSTOMER CARE IN ROLLING INDUSTRY

Customer care satisfaction is the DAVI way to conduct business.

Performed by professional, experienced, and specialized customer care Training Team:



**16** qualified and dedicated service engineers worldwide



### MASTER TRAINER

Master trainer (available for angle roll customers training)



DAVI Customer Care provides the following services:

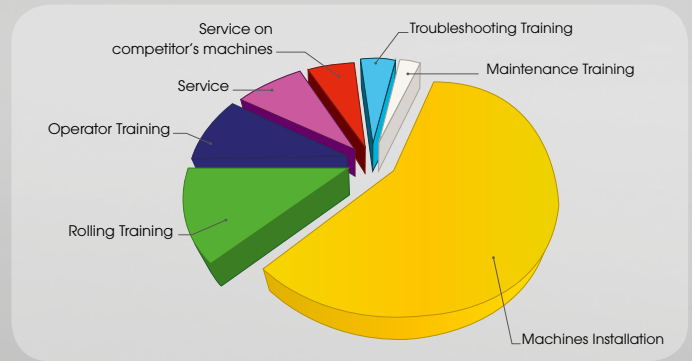















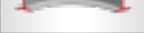

### 11.000 PARTS ON SHELF

More than 11.000 parts are available on shelf, in one of the largest Logistic Centers of the fabricating machine industry, are used for machines production or, if needed, as spare parts, to be shipped **ON SAME-DAY BASIS** to our clients.

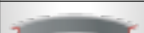

### DAVI CONTROLS: MAKES IT ALL!

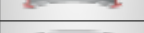
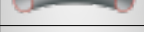
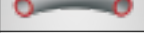

MODEL			MCP						
			9	11	14	18	20	24	28
	1 a	Flat on edge	80x18 ø800	100x25 ø700	125x32 ø1000	150x40 ø1400	180x50 ø1600	180x60 ø1600	220x60 ø2100
	2 a	Flat on flat	180x20 ø500	200x35 ø600	220x50 ø1000	250x60 ø1400	330x70 ø1400	340x80 ø1400	420x90 ø1900
	3 a	Square	50 ø500	65 ø680	85 ø1200	105 ø1600	120 ø1500	130 ø1700	150 ø2200
	4 a	Round	60 ø600	75 ø900	90 ø1100	110 ø1200	130 ø1400	140 ø1200	160 ø1500
	5 a**	L leg out	80x10 ø800	100x12 ø1000	120x15 ø1300	150x16 ø1200	180x18 ø1800	200x20 ø2000	200x28 ø2500
	6 a**	L leg in	80x10 ø700	100x10 ø1000	120x13 ø1100	150x15 ø1500	180x15 ø2000	180x20 ø2500	200x25 ø2500
	7 a	T leg out	80x9 ø700	100x12 ø800	120x15 ø1000	150x16 ø1000	180x18 ø1400	200x20 ø2000	200x28 ø2500
	8 a	T leg in	80x9 ø1300	100x10 ø800	120x13 ø1000	150x15 ø1200	180x15 ø1600	180x20 ø2500	200x25 ø2000
	9 a	T on one side	100x12 ø1000	100x12 ø1000	120x15 ø1000	150x16 ø1000	180x18 ø1400	200x20 ø1500	200x28 ø2500
	10 a*	Rectangular Hollow Section	100x50x5	120x50x4	150x50x5	180x70x8	200x75x8	210x90x8	240x110x10
	11 a*	Square Hollow Section	65x6	80x6	100x8	120x10	150x10	160x10	200x12
	12 a**	UPN leg out	UPN 140 ø600	UPN 180 ø800	UPN 220 ø900	UPN 300 ø1100	UPN 360 ø1300	UPN 400 ø1300	UPN 500 ø3000
	13 a**	UPN leg in	UPN 140 ø800	UPN 180 ø1000	UPN 220 ø1100	UPN 300 ø1200	UPN 360 ø1600	UPN 400 ø1600	UPN 500 ø3000
	14 a**	IPE easy way	IPE 140 ø600	IPE 180 ø1000	IPE 220 ø1000	IPE 300 ø1100	IPE 360 ø1200	IPE 400 ø1200	IPE 500 ø3500
	15 a**	HEA easy way	HEA 100 ø900	HEA 120 ø800	HEA 150 ø1100	HEA 180 ø1100	HEA 240 ø2500	HEA 260 ø2500	HEA 400 ø4500
	16 b*	Tube	96x2 ø1400	141x3,4 ø3000	168x3,4 ø2500	219x2,7 ø4300	273x4,2 ø5000	298x4,2 ø5000	368x4,5 ø10000
	17 b	Tube	76x6,3 ø700	114x6 ø1150	141x6 ø1150	168x7 ø2160	219x8 ø2550	254x8 ø3600	323,8x8,3 ø4100
	18 a** - c**	UPN hard way	UPN 65 ø4000	UPN 120 ø4500	UPN 160 ø8000	UPN 180 ø8000	UPN 220 ø9000	UPN 240 ø12000	UPN 260 ø12000
	19 a** - c**	IPE hard way	IPE 80 ø1200	IPE 120 ø2000	IPE 160 ø5000	IPE 180 ø6000	IPE 240 ø8000	IPE 240 ø7000	IPE 270 ø10000
	20 a** - c**	HEA hard way	Max section modulus 18-25 cm <sup>3</sup>	HEA 100 ø2800 HEB 100 ø3600	HEA 120 ø3000 HEB 120 ø3600	HEA 160 ø6000 HEB 140 ø6000	HEA 200 ø8800 HEB 180 ø6000	HEA 220 ø12000 HEB 200 ø8000	HEA 260 ø14000 HEB 240 ø10000
Section modulus	W cm <sup>3</sup>		25	90	150	220	450	570	940
Shafts ø	mm		85/85	105/105	140/120	180/160	200/180	240/220	280/260
Rolls ø (external)	mm		250	310	385	460	550	630	660
Electric Power	HP		10	20	25	30	40	50	60
Rolling Speed	Mt/min		7	7	7	7	7	7	7

a = Universal rolls; b = special rolls; c = special equipment

Additional set of special rolls might be necessary to reduce physical deformations. A set of special, customized rolls, ordered on request, with additional price, that matches exactly the section shape, will minimize the distortions, allowing to achieve the best results. The above mentioned capacities are based on sections in mild steel with a maximum of 270 N/mm<sup>2</sup> of Elastic Yield Point and 400 N/mm<sup>2</sup> UTS, rolled down to the stated diameters in one or a few passes. Capacities can be increased when rolling larger diameters. Tighter diameters can be achieved on lighter capacities\*\*.

Harder material reduces the announced capacities.

\*On this hollow section, due to its structural weakness, the achievable diameter heavily depends on the section distortion and deformation, rather than on the machine power.

To reduce distortion it is suggested to fill up the hollow section with sand and/or to use special tools.

\*\* For smaller sections than those listed, a set of further parts could be required (spacers and parts for the special equipment), therefore a technical analysis is recommended for a better evaluation.



# STRONGER, PRECISE AND MORE RELIABLE... ...New DAVI MCP Angle Roll!



MODEL			MCP					
			30	32	36A	36	40	52
	1 a	Flat on edge	250x60 ø2100	250x80 ø1900	250x100 ø2000	400x80 ø2100	500x130 ø3000	500x160 ø3000
	2 a	Flat on flat	470x80 ø1400	500x90 ø1200	500x110 ø1500	650x100 ø1500	1000x150 ø2000	1000x180 ø4000
	3 a	Square	160 ø2200	180 ø2200	200 ø2500	240 ø2200	310 ø2500	350 ø3000
	4 a	Round	180 ø2000	200 ø2200	220 ø2200	260 ø2000	380 ø2500	420 ø4000
	5 a**	L leg out	200x28 ø2000	200x28 ø1800	200x28 ø1700	200x28 ø1600	200x30 ø1600	200x30 ø1600
	6 a**	L leg in	200x25 ø2000	200x28 ø2500	200x28 ø2000	200x28 ø1800	200x30 ø1800	200x30 ø1800
	7 a	T leg out	200x28 ø2000	200x28 ø1800	200x28 ø1700	200x28 ø1600	200x30 ø1600	200x30 ø1600
	8 a	T leg in	200x25 ø1800	200x28 ø2500	200x28 ø2000	200x28 ø1800	200x30 ø1800	200x30 ø1800
	9 a	T on one side	200x28 ø2000	200x28 ø1800	200x28 ø1700	200x28 ø1600	200x30 ø1600	200x30 ø1600
	10 a*	Rectangular Hollow Section	250x125x12	250x125x12	280x150x12	420x200x12	660x610x16	600x610x20
	11 a*	Square Hollow Section	220x13	225x12	260x12	400x16	508x20	600x20
	12 a**	UPN leg out	UPN 500 ø2000	UPN 550 ø2200	UPN 600 ø1500	UPN 1000 ø4000	UPN 1000 ø3500	UPN 1000 ø3000
	13 a**	UPN leg in	UPN 500 ø2000	UPN 550 ø3000	UPN 600 ø1500	UPN 1000 ø4000	UPN 1000 ø3500	UPN 1000 ø3000
	14 a**	IPE easy way	IPE 500 ø2500	IPE 550 ø2200	IPE 600 ø2500	IPE 1000 ø5000	IPE 1000 ø3000	IPE 1000 ø3000
	15 a**	HEA easy way	HEA 400 ø3500	HEA 450 ø2700	HEA 600 ø3000	HEA 1000 ø5000	HEM1000 ø3000	HEM 1000 ø3000
	16 b*	Tube	370x5,5 ø12000	406x6,3 ø15000	473x6,3 ø15000	558x12,7 ø10000	660x8 ø20000	711x16 ø40000
	17 b	Tube	323,8x10,3 ø4100	355,6x11,1 ø5100	355x12,7 ø7600	508x15 ø10000	609,6x17,5 ø15300	609,6x24,6 ø20000
	18 a**-c**	UPN hard way	UPN 280 ø16000	UPN 300 ø20000	UPN 320 ø20000	UPN 400 ø38000	UPN 700 ø80000	UPN 800 ø100000
	19 a**-c**	IPE hard way	IPE 300 ø11000	IPE 400 ø25000	IPE 400 ø22000	IPE 550 ø25000	IPE 800 ø40000	IPE 1000 ø55000
	20 a**-c**	HEA hard way	HEA 280 ø11400 HEB 260 ø10000	HEA 320 ø20000 HEB 300 ø15000	HEA 340 ø30000 HEB 320 ø15000	HEA 550 ø40000 HEB 500 ø28000	HEA 800 ø45000 HEB 700 ø45000	HEA 1000 ø55000 HEB 800 ø55000
Section modulus	W cm <sup>3</sup>		1150	1700	1900	4300	7700	11500
Shafts ø	mm		300/280	320/320	360/360	360/360	400/400	520/420
Rolls ø (external)	mm		740	780	800	800	840	840
Electric Power	HP		100	100	100	125	150	230
Rolling Speed	Mt/min		7	7	7	7	7	7

a = Universal rolls; b = special rolls; c = special equipment

Additional set of special rolls might be necessary to reduce physical deformations. A set of special, customized rolls, ordered on request, with additional price, that matches exactly the section shape, will minimize the distortions, allowing to achieve the best results. The above mentioned capacities are based on sections in mild steel with a maximum of 270 N/mm<sup>2</sup> of Elastic Yield Point and 400 N/mm<sup>2</sup> UTS, rolled down to the stated diameters in one or a few passes. Capacities can be increased when rolling larger diameters. Tighter diameters can be achieved on lighter capacities\*\*. Harder material reduces the announced capacities.

\*On this hollow section, due to its structural weakness, the achievable diameter heavily depends on the section distortion and deformation, rather than on the machine power.

To reduce distortion it is suggested to fill up the hollow section with sand and/or to use special tools.

\*\* For smaller sections than those listed, a set of further parts could be required (spacers and parts for the special equipment), therefore a technical analysis is recommended for a better evaluation.



**DAVI** manufactures high quality section bending machines, the perfect machine for any type of beams, sections and pipes, especially the heaviest. These machines can be equipped with many different accessories, to provide the most ergonomic and productive solutions. **DAVI** provides the most user friendly **AUTOMATION**, with software from the simplest to the most technically advanced for angle rolls.

**DAVI** products portfolio includes 3 and 4 roll plate rolls, with capacity in thickness up to 400 mm and in width up to 12 m, suitable for any applications, particularly the heavy duty ones.

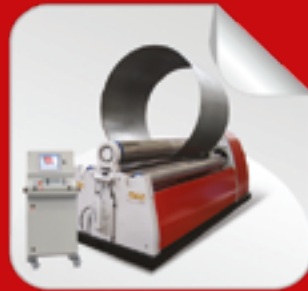

**DAVI** partner



**UCIMU**



PROMAU S.r.l.

Via Civinelli 1150 | 47522 Cesena (FC) ITALY  
 Tel. +39 0547 319611 | Fax +39 0547 317850  
 davi-sales@davi.com | www.davi.com